

LEGEND

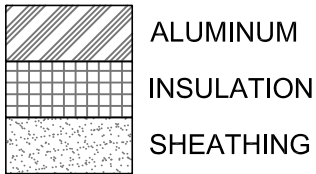

NOTE: BVTC TO SUPPLY TERRACLAD™ PANELS, VERTICAL TRACK w/ GASKET, AND CLIPS w/ ISOLATORS. ALL OTHER COMPONENTS TO BE PROVIDED BY OTHERS.

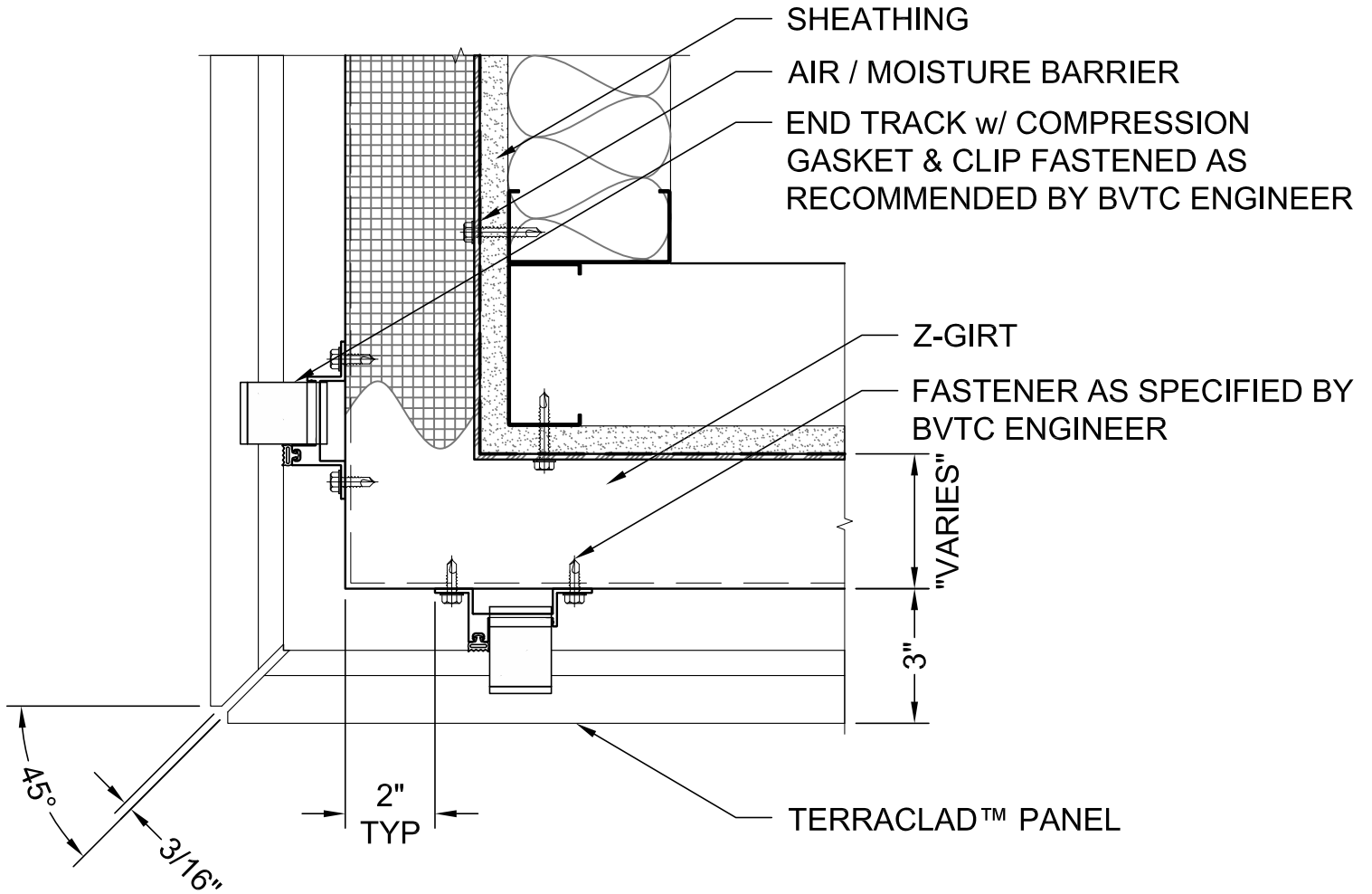

**PLAN DETAIL
3/16" QUIRK MITERED CORNER**

1

Scale: 3" = 1'-0"

ALL RIGHTS RESERVED. NO PART OF THIS WORK MAY BE REPRODUCED OR COPIED IN ANY FORM OR BY ANY MEANS -GRAPHIC, ELECTRONIC, OR MECHANICAL, INCLUDING PHOTOCOPYING, RECORDING, TAPING OR INFORMATION AND RETRIEVAL SYSTEMS - WITHOUT WRITTEN PERMISSION OF BOSTON VALLEY TERRA COTTA.



TerraClad™
6860 SOUTH ABBOTT ROAD
ORCHARD PARK, NY 14127
PHONE: 716-649-7490
FAX: 716-649-9662
www.terraclad.com

**CORNER
DETAIL
DRAWING**

SCALE:	3" = 1'-0"
DATE:	07/14/14
DRAWN:	EDS
PAGE NUMBER	CR-1

LEGEND

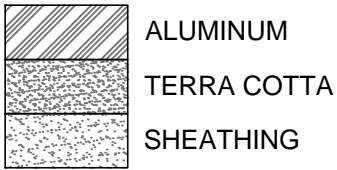

NOTE: BVTC TO SUPPLY TERRACLAD™ PANELS, VERTICAL TRACK w/ GASKET, AND CLIPS w/ ISOLATORS. ALL OTHER COMPONENTS TO BE PROVIDED BY OTHERS.

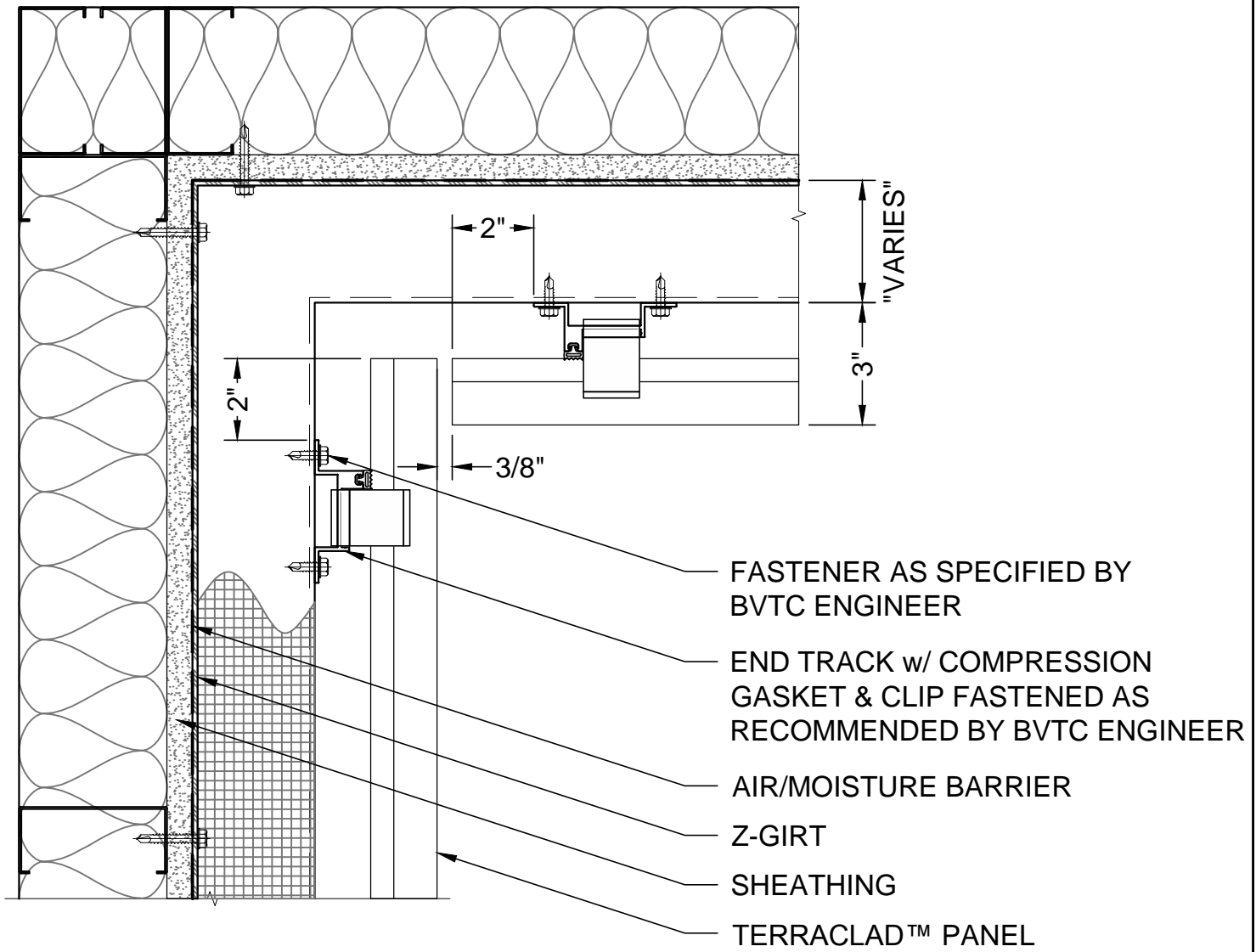

1 PLAN DETAIL
INSIDE CORNER w/ 3/8" JOINT
 Scale: 3" = 1'-0"

ALL RIGHTS RESERVED. NO PART OF THIS WORK MAY BE REPRODUCED OR COPIED IN ANY FORM OR BY ANY MEANS -GRAPHIC, ELECTRONIC, OR MECHANICAL, INCLUDING PHOTOCOPYING, RECORDING, TAPING OR INFORMATION AND RETRIEVAL SYSTEMS - WITHOUT WRITTEN PERMISSION OF BOSTON VALLEY TERRA COTTA.



TerraClad™
 6860 SOUTH ABBOTT ROAD
 ORCHARD PARK, NY 14127
 PHONE: 716-649-7490
 FAX: 716-649-9662
www.terraclad.com

**CORNER
 DETAIL
 DRAWING**

SCALE:	3" = 1'-0"
DATE:	07/14/14
DRAWN:	EDS
PAGE NUMBER	CR-2

LEGEND

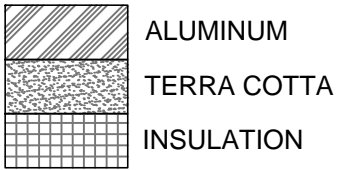

NOTE: BVTC TO SUPPLY TERRACLAD™ PANELS, VERTICAL TRACK w/ GASKET, AND CLIPS w/ ISOLATORS. ALL OTHER COMPONENTS TO BE PROVIDED BY OTHERS.

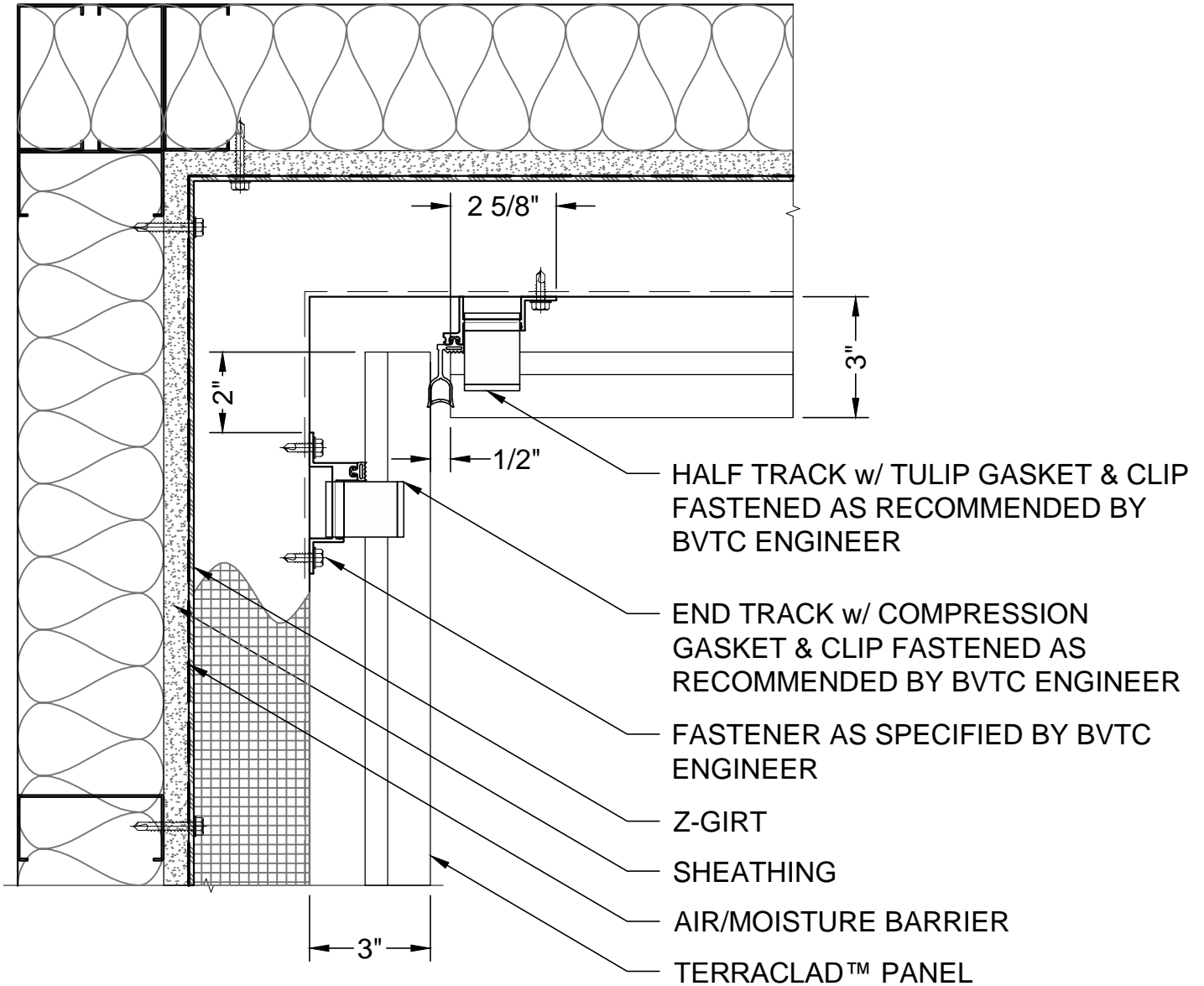

**PLAN DETAIL, INSIDE CORNER
1/2" JOINT w/ TULIP GASKET**

1

Scale: 3" = 1'-0"

ALL RIGHTS RESERVED. NO PART OF THIS WORK MAY BE REPRODUCED OR COPIED IN ANY FORM OR BY ANY MEANS -GRAPHIC, ELECTRONIC, OR MECHANICAL, INCLUDING PHOTOCOPYING, RECORDING, TAPING OR INFORMATION AND RETRIEVAL SYSTEMS - WITHOUT WRITTEN PERMISSION OF BOSTON VALLEY TERRA COTTA.



TerraClad™
6860 SOUTH ABBOTT ROAD
ORCHARD PARK, NY 14127
PHONE: 716-649-7490
FAX: 716-649-9662
www.terraclad.com

**CORNER
DETAIL
DRAWING**

SCALE:	3" = 1'-0"
DATE:	07/14/14
DRAWN:	EDS
PAGE NUMBER	CR-3

LEGEND

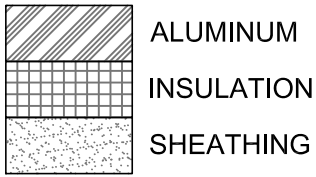

NOTE: BVTC TO SUPPLY TERRACLAD™ PANELS, VERTICAL TRACK w/ GASKET, AND CLIPS w/ ISOLATORS. ALL OTHER COMPONENTS TO BE PROVIDED BY OTHERS.

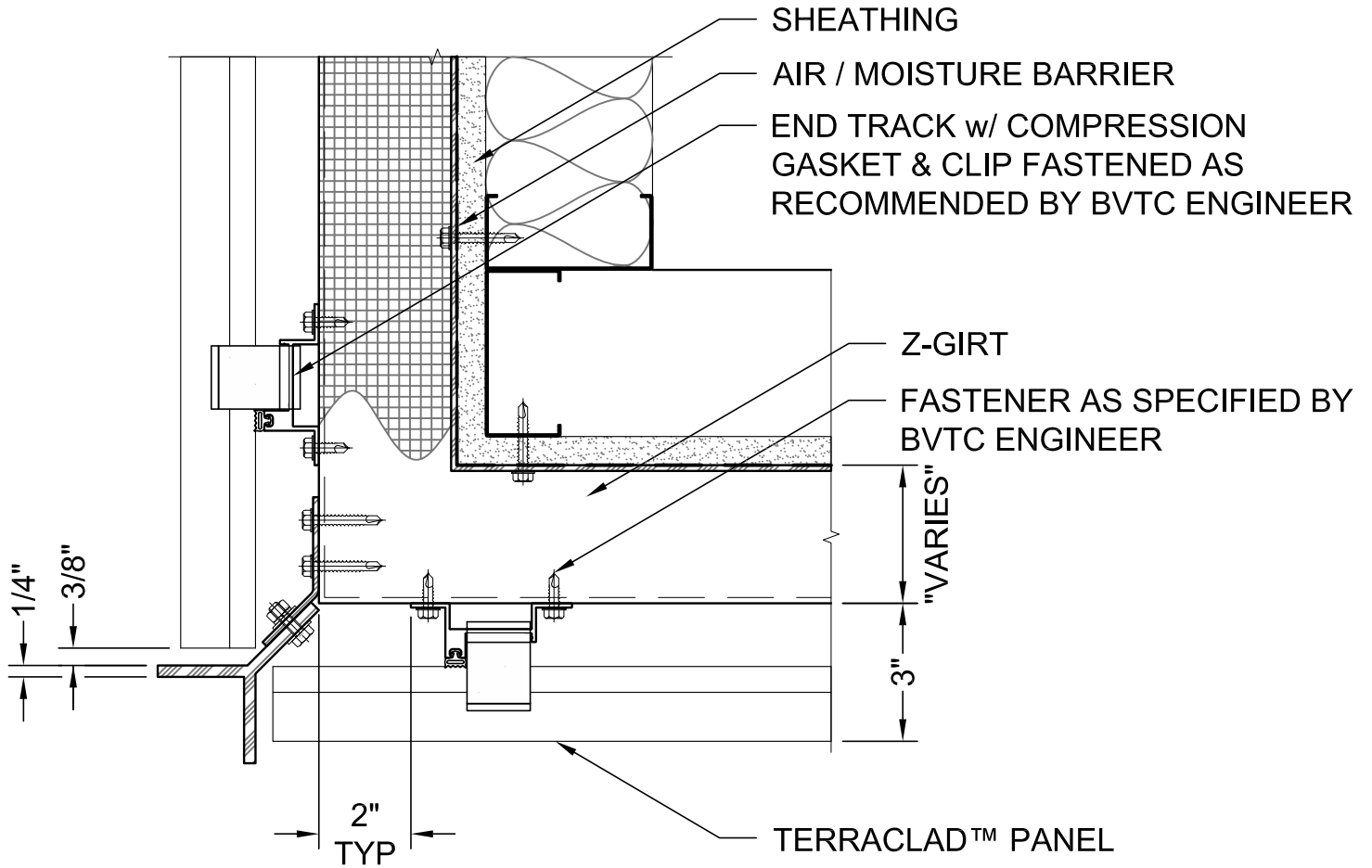

**PLAN DETAIL
CORNER w/ ALUMINUM TRIM**

1

Scale: 3" = 1'-0"

ALL RIGHTS RESERVED. NO PART OF THIS WORK MAY BE REPRODUCED OR COPIED IN ANY FORM OR BY ANY MEANS -GRAPHIC, ELECTRONIC, OR MECHANICAL, INCLUDING PHOTOCOPYING, RECORDING, TAPING OR INFORMATION AND RETRIEVAL SYSTEMS - WITHOUT WRITTEN PERMISSION OF BOSTON VALLEY TERRA COTTA.



TerraClad™
6860 SOUTH ABBOTT ROAD
ORCHARD PARK, NY 14127
PHONE: 716-649-7490
FAX: 716-649-9662
www.terraclad.com

**CORNER
DETAIL
DRAWING**

SCALE:	3" = 1'-0"
DATE:	04/17/15
DRAWN:	AJB
PAGE NUMBER	CR-4

LEGEND

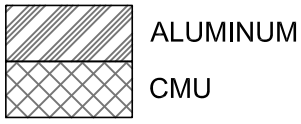

NOTE: BVTC TO SUPPLY TERRACLAD™ PANELS, VERTICAL TRACK w/ GASKET, AND CLIPS w/ ISOLATORS. ALL OTHER COMPONENTS TO BE PROVIDED BY OTHERS.

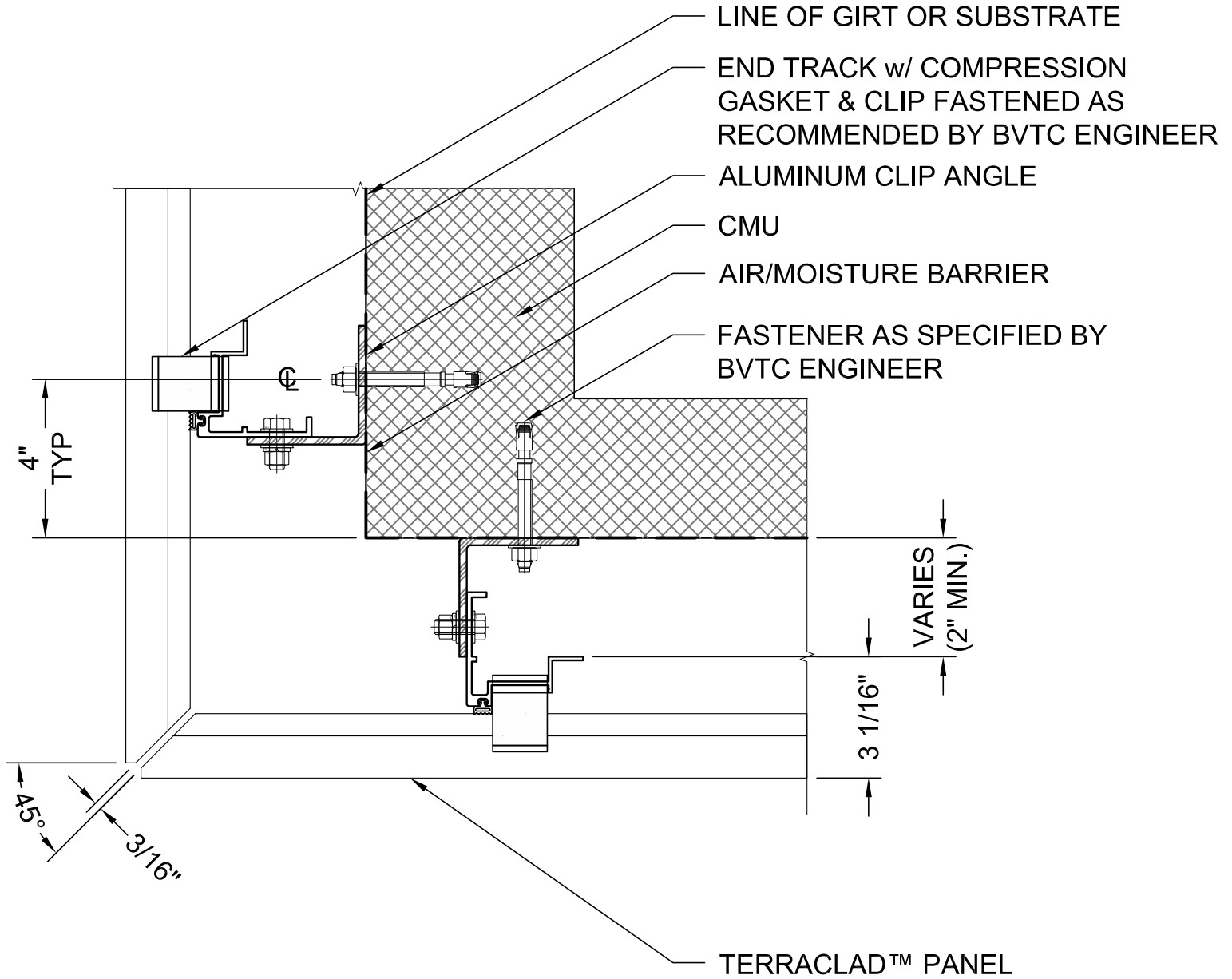

**PLAN DETAIL, FLANGED END TRACK
3/16" QUIRK MITERED CORNER**

1

Scale: 3" = 1'-0"

ALL RIGHTS RESERVED. NO PART OF THIS WORK MAY BE REPRODUCED OR COPIED IN ANY FORM OR BY ANY MEANS -GRAPHIC, ELECTRONIC, OR MECHANICAL, INCLUDING PHOTOCOPYING, RECORDING, TAPING OR INFORMATION AND RETRIEVAL SYSTEMS - WITHOUT WRITTEN PERMISSION OF BOSTON VALLEY TERRA COTTA.



TerraClad™
6860 SOUTH ABBOTT ROAD
ORCHARD PARK, NY 14127
PHONE: 716-649-7490
FAX: 716-649-9662
www.terraclad.com

**CORNER
DETAIL
DRAWING**

SCALE:	3" = 1'-0"
DATE:	07/14/14
DRAWN:	EDS
PAGE NUMBER	CR-5

LEGEND

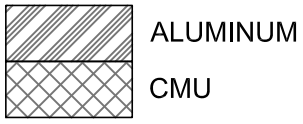

NOTE: BVTC TO SUPPLY TERRACLAD™ PANELS, VERTICAL TRACK w/ GASKET, AND CLIPS w/ ISOLATORS. ALL OTHER COMPONENTS TO BE PROVIDED BY OTHERS.

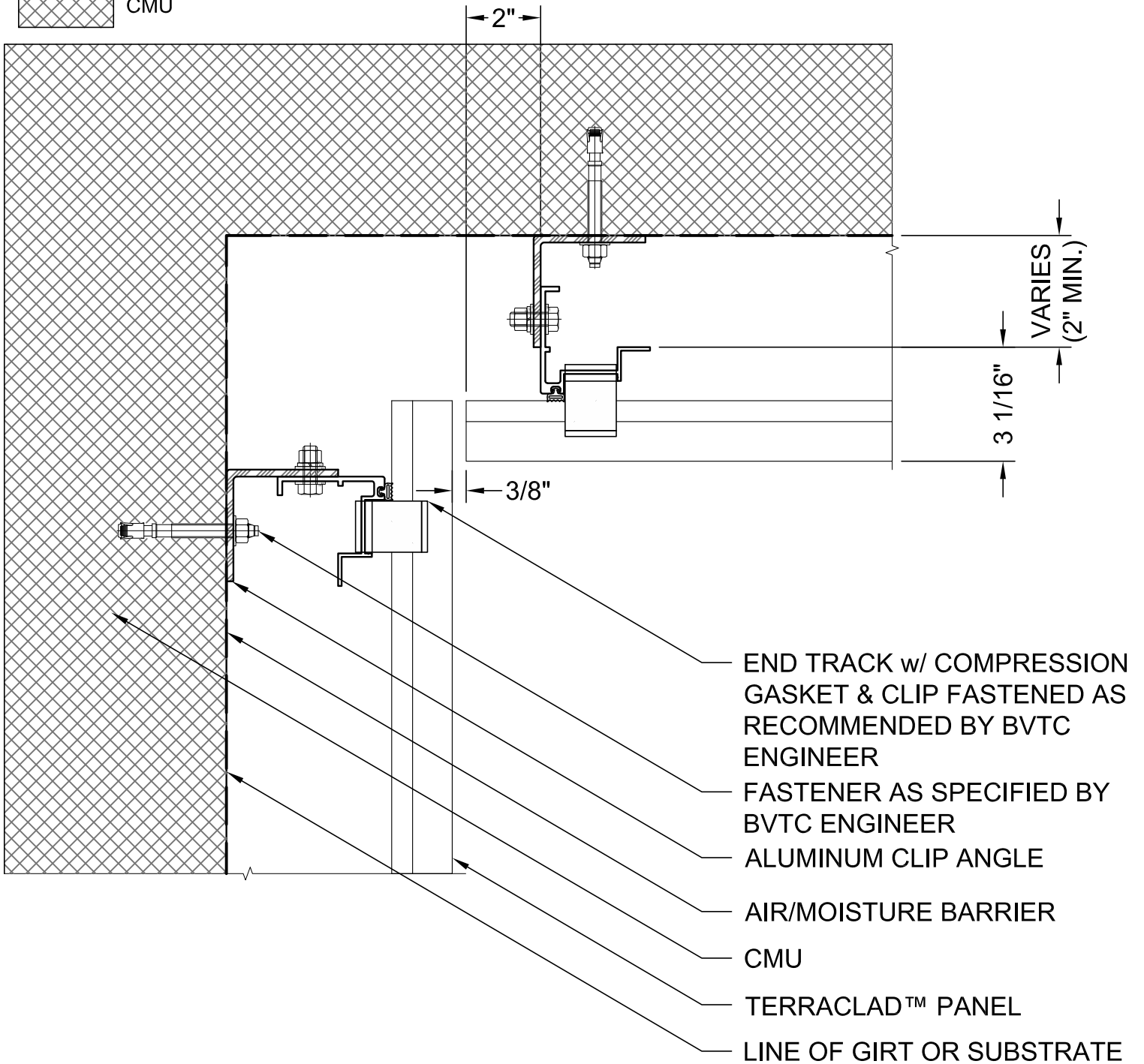

**PLAN DETAIL, FLANGED END TRACK
INSIDE CORNER w/ 3/8" JOINT**

1

Scale: 3" = 1'-0"

ALL RIGHTS RESERVED. NO PART OF THIS WORK MAY BE REPRODUCED OR COPIED IN ANY FORM OR BY ANY MEANS -GRAPHIC, ELECTRONIC, OR MECHANICAL, INCLUDING PHOTOCOPYING, RECORDING, TAPING OR INFORMATION AND RETRIEVAL SYSTEMS - WITHOUT WRITTEN PERMISSION OF BOSTON VALLEY TERRA COTTA.



TerraClad™
6860 SOUTH ABBOTT ROAD
ORCHARD PARK, NY 14127
PHONE: 716-649-7490
FAX: 716-649-9662
www.terraclad.com

**CORNER
DETAIL
DRAWING**

SCALE:	3" = 1'-0"
DATE:	07/14/14
DRAWN:	EDS
PAGE NUMBER	CR-6